

## Bullet Network Camera Quick Setup Guide

NO:101-300-0401-01  
Issue:1.0

### Precautions

Fully understand this document before using this device, and strictly observe rules in this document when using this device. If you install this device in public places, provide the tip "You have entered the area of electronic surveillance" in an eye-catching place. Failure to correctly use electrical products may cause fire and severe injuries.

<b>WARNING</b>	It alerts you to moderate dangers which, if not avoided, may cause minor or moderate injuries.
<b>CAUTION</b>	It alerts you to risks. Neglect of these risks may cause device damage, data loss, device performance deterioration, or unpredictable results.
<b>NOTE</b>	It provides additional information.

### **WARNING**

- Strictly observe installation requirements when installing the device. The manufacturer shall not be held responsible for device damage caused by users' non-conformance to these requirements.
- Strictly conform to local electrical safety standards and use power adapters that are marked with the LPS standard when installing and using this device. Otherwise, this device may be damaged.
- Use accessories delivered with this device. The voltage must meet input voltage requirements for this device.
- If this device is installed in places with unsteady voltage, ground this device to discharge high energy such as electrical surges in order to prevent the power supply from burning out.
- When this device is in use, ensure that no water or any liquid flows into the device. If water or liquid unexpectedly flows into the device, immediately power off the device and disconnect all cables (such as power cables and network cables) from this device.
- Do not focus strong light (such as lighted bulbs or sunlight) on

this device. Otherwise, the service life of the image sensor may be shortened.

- If this device is installed in places where thunder and lightning frequently occur, ground the device nearby to discharge high energy such as thunder strikes in order to prevent device damage.

### **CAUTION**

- Avoid heavy loads, intensive shakes, and soaking to prevent damages during transportation and storage. The warranty does not cover any device damage that is caused during secondary packaging and transportation after the original packaging is taken apart.
- Protect this device from fall-down and intensive strikes, keep the device away from magnetic field interference, and do not install the device in places with shaking surfaces or under shocks.
- Clean the device with a soft dry cloth. For stubborn dirt, dip the cloth into slight neutral cleanser, gently wipe the dirt with the cloth, and then dry the device.
- Do not jam the ventilation opening. Follow the installation instructions provided in this document when installing the device.
- Keep the device away from heat sources such as radiators, electric heaters, or other heat equipment.
- Keep the device away from moist, dusty, extremely hot or cold places, or places with strong electric radiation.
- If the device is installed outdoors, take insect- and moisture-proof measures to avoid circuit board corrosion that can affect monitoring.
- Remove the power plug if the device is idle for a long time.
- Before unpacking, check whether the fragile sticker is damaged. If the fragile sticker is damaged, contact customer services or sales personnel. The manufacturer shall not be held responsible for any artificial damage of the fragile sticker.

### Special Announcement

- All complete products sold by the manufacturer are delivered along with nameplates, quick setup guide and accessories after strict inspection. The manufacturer shall not be held responsible for counterfeit products.
- The manufacturer will update this manual according to product function enhancement or changes and regularly update the software and hardware described in this manual. Update information will be added to new versions of this manual without prior notice.
- This manual may contain misprints, technology information that is not accurate enough, or product function and operation description that is slightly inconsistent with the actual product, the final interpretation of company is as a standard.
- This manual is only for reference and does not ensure that the information is totally consistent with the actual product. For consistency, see the actual product.

### **NOTE**

For more information, please refer to CD and website.

## 1 Open Package Examination

Open the package, check the appearance of product for no obvious damage, and confirm the item list for table 1-1 is consistent.

Table 1-1 Packing list

Component	Quantity	Remark
Bullet Network Camera	1	
Quick Setup Guide	1	
CD-ROM	1	
Installation location sticker	1	
Hex Wrench	1	
Swell plastic button $\phi 5.6 \times 29\text{mm}$	4	
Stainless self-tapping screw PA4.0 $\times 35\text{mm}$	4	
Stainless hexagon screw M4 $\times 10\text{mm}$	4	
Base	1	
Network access port protective cover	1	
Alarm wiring terminal	2	Optional
Micro SD card set	1	
Waterproof rubber seal	1	
Video patch cord	1	Optional

## 2 Device Structure

### 2.1 Device Ports

#### **NOTE**

Different device may have different ports and multi-head cable, please refer to the actual product.

Figure 2-1 Hardware ports

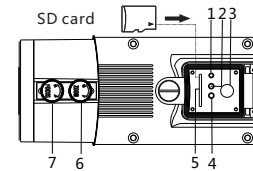

Table 2-1 Hardware ports description

ID	Port Name	Description
1	Reset button	Restores the camera to the factory settings by pressing and holding this button for more than five seconds.
2	NIC indicator	When there is a network activity, the indicator flashes.
3	BNC Video	Sends an analog video signal. You can connect the camera to a TV monitor through this port to view the analog video.
4	SD card indicator	Indicate the card status, the status is described as follows: <ul style="list-style-type: none"> <li>Off: No card is inserted</li> <li>On: A SD card is inserted.</li> </ul>
5	SD card slot	Install a SD card. <p> <b>NOTE</b></p> <ul style="list-style-type: none"> <li>Before install a SD card, verify the card not in write protection state.</li> <li>Before remove the SD card. Verify the card not in write protection state. Otherwise, the data may be lost, or the SD card may be damaged.</li> </ul>
6	Zoom button	<b>NOTE</b>
7	Focusing button	Applied for MF products only.

Figure2-2 Multi-head cable

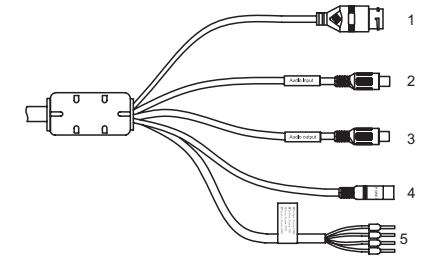

Table 2-2 Multi-head cable description

ID	Core	Description	Remark
1	Network access port	Connects to a standard Ethernet cable.	
2	Audio input port	Receives an analog audio signal from devices such as a sound pickup device.	Applied for camera with audio function
3	Audio output port	Connects to an external audio device such as a speaker.	
4	Power supply (DC 12V)	Connects to a 12V(-15%~+10%) direct current (DC) power supply.	
5	Gray core	Alarm output terminal A(normal open)	Applied for alarm function
	Purple core	Alarm output terminal B(normal open)	
	Yellow core	Alarm input positive terminal	
	Orange core	Alarm input ground terminal	

### 2.2 Camera Dimensions

#### **NOTE**

Different device may have different dimensions, please refer to the actual product.

Figure 2-3 Dimensions ( Unit:mm )

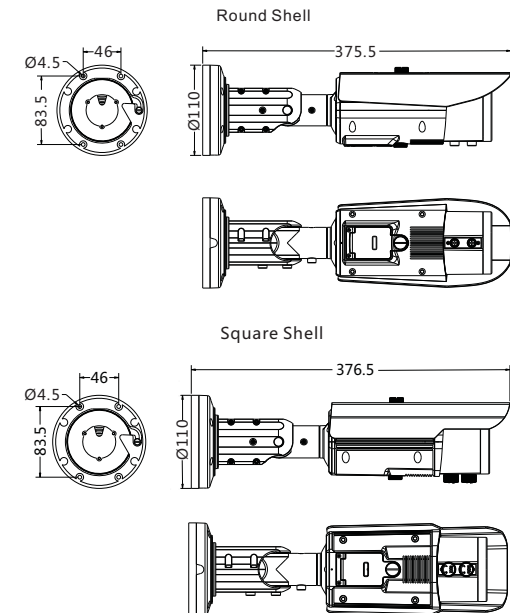

### 3 Device Installation

The Bullet Network Camera can be installed on the ceiling or wall. If the camera is installed on a concrete wall, install the swell plastic button before installing the bracket. If the camera is installed on a wooden wall, use self-tapping screws to install the bracket directly.

#### NOTE

The wall where the bracket is installed must be able to bear at least three times of the total weight of the bracket and the camera.

#### Installation Steps:

- Step 1 Stick the Installation location sticker on the ceiling or wall, Drill three holes based on the marks on the sticker. Drive the swell plastic buttons into the holes.
- Step 2 Take out the base and the stainless self-tapping screws delivered with the camera. Use the stainless self-tapping screws to secure the base onto the ceiling or wall, and mount the camera on the slot of the base using screws at the bottom of the camera, as shown in figure 3-1.

Figure 3-1 Installing camera

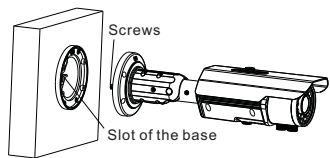

- Step 3 Adjust the position of the camera, expose the cable outlet, and connect the multi-head cable of the camera.
- Step 4 Adjust the position of the camera based on the arrows marked on the figure 3-2. Align the installation holes at the bottom of the camera with the screw holes on the base and fix the camera on the base, as shown in figure 3-2.

Figure 3-2 Aligning the screw holes

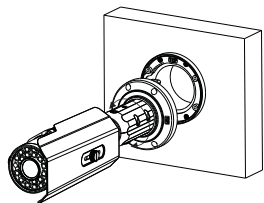

- Step 5 Use the hex Wrench to loosen screws 1 to 3, as shown in figure 3-3. To rotate the part 1 of the camera for 360°, loosen screw 1. To rotate the part 2 of the camera for 90°, loosen screw 2. To rotate the part 3 of the camera for 360°, loosen screw 3.

Figure 3-3 Loosening screws

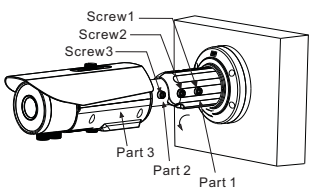

- Step 6 Fasten screws.
- Step 7 Adjust the zoom button and the focusing button until the view is clear (This step is applied for MF products only).

### 4 Quick Configuration(e.g IE)

#### 4.1 Login

- Step 1 Open the Internet Explorer, enter the IP address of IP camera (default value: 192.168.0.120) in the address box, and press Enter. The login page is displayed, as shown in figure 4-1.
- Step 2 Input the user name and password.

#### NOTE

The default user name is admin. The default password is admin. Change the password when you log in the system for first time to ensure system security. You can change the system display language on the login page.

Figure 4-1 Login

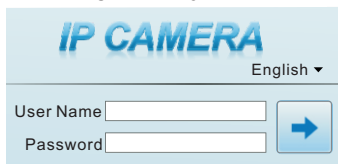

- Step 3 Click Login, the main page is displayed.

#### 4.2 Modify IP address

- Choose **Configuration > Device > Local Network**, the **Local Network** page is displayed. Enter the IP address in the IP Address box and click **Apply** as shown in figure 4-2.

After the success of the IP address setting, please use the new IP address to log in the Web interface.

Figure 4-2 Local Network

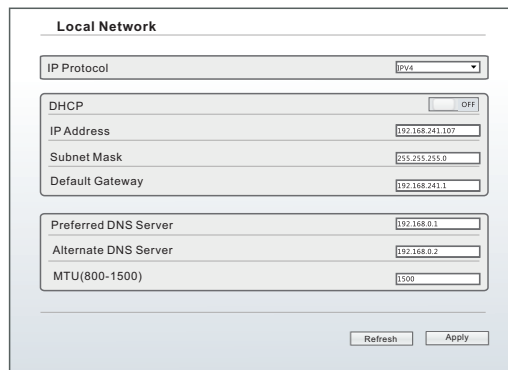

#### 4.3 Browsing Video

To ensure the real-time video can be played properly, you must perform the following operation when you log in the web for the first time:

- Step 1 the Internet Explorer. Choose **Tools > Internet options > Security > Trusted sites > Sites**, in the display dialog box, click **Add**, as shown in figure 4-3.
- Step 2 In the Internet Explorer, choose **Tool > Internet Options > Security > Customer level**, and set **Download unsigned ActiveX control and initialize and script ActiveX controls not marked as safe for scripting under ActiveX controls and plug-ins to Enable**, as shown in figure 4-4.

Figure 4-3 Adding a trusted site

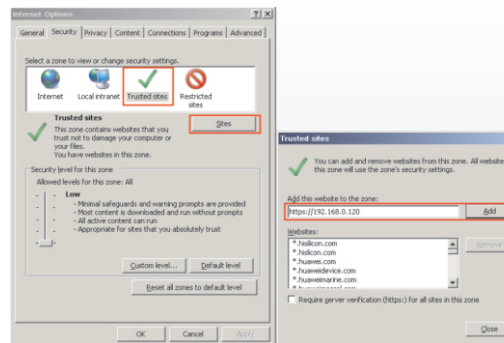
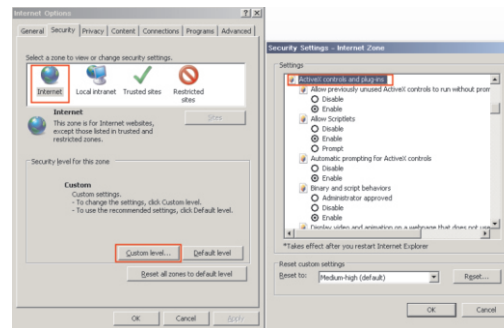

Figure 4-4 Configuring ActiveX control and plug-in



- Step 3 Download and install the player control as prompted.

#### NOTE

If the repair tips displayed when installing the control, please ignore the prompt, and continue the installation, the login page is displayed when the control is loaded.

To browse a real-time video, click Live Video. The Live Video page is displayed, as shown in figure 4-5.

Figure 4-5 Live Video



#### 4.4 Two-way audio

#### NOTE

Partial camera do not support two-way audio, this section do not apply.

##### 4.4.1 Camera ↔ PC

#### Connection :

- Step 1 Connect microphone to audio input interface of camera.
- Step 2 Connect speaker to the PC audio output interface.
- Step 3 Log in camera Web, click to turn on two-way audio.

#### 4.4.2 PC ↔ Camera

- Step 1 Connect microphone to PC audio input interface.
- Step 2 Connect speaker to camera audio out interface.
- Step 3 Log in camera Web, click to turn on two-way audio.

#### 4.5 Alarm Configuration

#### NOTE

Partial camera do not support alarm, this section do not apply.

#### Alarm input and Alarm output connection:

- Step 1 Connect alarm input device to Alarm IN0 and Alarm COM0 of multi-head cable.
- Step 2 Connect alarm output device to Alarm OUT1 and Alarm COM1 of multi-head cable, alarm output interface can connect to normal open device only.
- Step 3 Log in Web, Choose **Configuration>Alarm>I/O Alarm**, set the parameters as shown in figure 4-6.
- Step 4 Choose **Configuration>Alarm>I/O Alarm Linkage**, enable the I/O Alarm and set the parameters of Schedule Setting.

Figure 4-6 Alarm

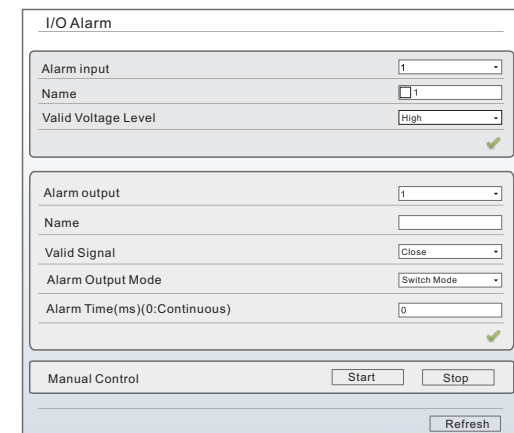

### 5 Appendix : Hazardous Substance Declaration

Component	Hazardous Substance or Element					
	Plumbum (Pb)	Mercury (Hg)	Cadmium (Cd)	Hexavalent Chromium (Cr6+)	Polybrominated Biphenyls (PBB)	Polybrominated Diphenyl Ethers (PBDE)
Structural part	x	o	o	o	o	o
Board/circuit module	x	o	o	o	o	o
Cable connector	x	o	o	o	o	o
Accessories	x	o	o	o	o	o

#### NOTE

○: indicates that the concentration of the hazardous substance in all homogeneous substances of the component is within the limit specified in SJ/T 11363-2006 Requirements for Concentration Limits for Certain Hazardous Substances in Electronic Information Products.

x: indicates that the concentration of the hazardous substance in at least one homogeneous substance of the component exceeds the limit specified in SJ/T 11363-2006 Requirements for Concentration Limits for Certain Hazardous Substances in Electronic Information Products.